



BM 10S



BM 12S

User's Manual

dynaudioacoustics
IF IT'S THERE - YOU'LL KNOW IT

IMPORTANT SAFETY INSTRUCTIONS



The lightning flash with an arrowhead symbol within an equilateral triangle, is intended to alert the user to the presence of uninsulated “dangerous voltage” within the product’s enclosure that may be of sufficient magnitude to constitute a risk of electric shock to persons.



The exclamation point within an equilateral triangle is intended to alert the user to the presence of important operating and maintenance (servicing) instructions in the literature accompanying the product.

- 1 Read these instructions.
- 2 Keep these instructions.
- 3 Heed all warnings.
- 4 Follow all instructions.
- 5 Do not use this apparatus near water.
- 6 Clean only with dry cloth.
- 7 Do not block any ventilation openings. Install in accordance with the manufacturer's instructions.
- 8 Do not install near any heat sources such as radiators, heat registers, stoves, or other apparatus (including amplifiers) that produce heat.
- 9 Do not defeat the safety purpose of the polarized or grounding-type plug. A polarized plug has two blades with one wider than the other. A grounding type plug has two blades and a third grounding prong. The wide blade or the third prong are provided for your safety. If the provided plug does not fit into your outlet, consult an electrician for replacement of the obsolete outlet.
- 10 Protect the power cord from being walked on or pinched particularly at plugs, convenience receptacles, and the point where they exit from the apparatus.
- 11 Only use attachments/accessories specified by the manufacturer.
- 12  Use only with the cart, stand, tripod, bracket, or table specified by the manufacturer, or sold with the apparatus. When a cart is used, use caution when moving the cart/apparatus combination to avoid injury from tip-over.
- 13 Unplug this apparatus during lightning storms or when unused for long periods of time.
- 14 Refer all servicing to qualified service personnel. Servicing is required when the apparatus has been damaged in any way, such as power-supply cord or plug is damaged, liquid has been spilled or objects have fallen into the apparatus, the apparatus has been exposed to rain or moisture, does not operate normally, or has been dropped.

Warning!

- To reduce the risk of fire or electrical shock, do not expose this equipment to dripping or splashing and ensure that no objects filled with liquids, such as vases, are placed on the equipment.
- This apparatus must be earthed.
- Use a three wire grounding type line cord like the one supplied with the product.
- Be advised that different operating voltages require the use of different types of line cord and attachment plugs.
- Check the voltage in your area and use the correct type. See table below:

Voltage	Line plug according to standard.
110-125V	UL817 and CSA C22.2 no 42.
220-230V	CEE 7 page VII, SR section 107-2-D1/IEC 83 page C4.
240V	BS 1363 of 1984. Specification for 13A fused plugs and switched and un-switched socket outlets.

- This equipment should be installed near the socket outlet and disconnection of the device should be easily accessible.
- To completely disconnect from AC mains, disconnect the power supply cord from the AC receptable.
- The mains plug of the power supply shall remain readily operable.
- Do not install in a confined space.
- Do not open the unit - risk of electric shock inside.

Caution:

You are cautioned that any change or modifications not expressly approved in this manual could void your authority to operate this equipment.

Service

- There are no user-serviceable parts inside.
- All service must be performed by qualified personnel.

IMPORTANT SAFETY INSTRUCTIONS

This equipment has been tested and found to comply with the limits for a Class B Digital device, pursuant to part 15 of the FCC rules. These limits are designed to provide reasonable protection against harmful interference in residential installations. This equipment generates, uses and can radiate radio frequency energy and, if not installed and used in accordance with the instructions, may cause harmful interference to radio communications. However, there is no guarantee that interference will not occur in a particular installation. If this equipment does cause harmful interference to radio or television reception, which can be determined by turning the equipment off and on. The user is encouraged to try to correct the interference by one or more of the following measures:

- Reorient or relocate the receiving antenna.
- Increase the separation between the equipment and receiver.
- Connect the equipment into an outlet on a circuit different from that to which the receiver is connected.
- Consult the dealer or an experienced radio/TV technician for help.

Caution:

You are cautioned that any change or modifications not expressly approved in this manual could void your authority to operate this equipment.

For the customers in Canada:

This Class B Digital apparatus meets all requirements of the Canadian Interference-Causing Equipment Regulations ICES-003.

Cet appareil numérique de la classe B respecte toutes les exigences du Règlement sur le matériel brouilleur du Canada.

This Class B digital apparatus complies with Canadian ICES-003. Cet appareil numérique de la classe B est conforme à la norme NMB-003 du Canada.

Advice on maintenance and care

Maintenance / Care

No special maintenance is necessary. Cleaning the cabinet's surfaces with a damp cloth will suffice. Never use cleaners or chemicals.

About Wood Veneer Finishes

Dynaudio speaker cabinets are finished with the highest quality real wood veneers. As with many natural products, wood finish may change color over time, particularly if exposed to bright sunlight.

Certificate Of Conformity

TC Electronic A/S, Sindalsvej 34, 8240 Risskov, Denmark, hereby declares on own responsibility that following products:

BM12S and BM10S

- that are covered by this certificate and marked with CE-label conforms with following standards:

EN 60065 (IEC 60065)	Safety requirements for mains operated electronic and related apparatus for household and similar general use
EN 55103-1	Product family standard for audio, video, audio-visual and entertainment lighting control apparatus for professional use. Part 1: Emission.
EN 55103-2	Product family standard for audio, video, audio-visual and entertainment lighting control apparatus for professional use. Part 2: Immunity.

With reference to regulations in following directives:
73/23/EEC, 89/336/EEC

Issued in Risskov, April 2004

Mads Peter Lübeck
Chief Executive Officer

TABLE OF CONTENTS

Introduction

<i>Important Safety Instructions & Certificate of Conformity and Maintenance . . . a-b</i>	
<i>Table of Contents</i>	<i>3</i>
<i>Introduction</i>	<i>4</i>
<i>Quick Setup Reference</i>	<i>5</i>
<i>Installation and Connections</i>	<i>6</i>
<i>Unpacking</i>	<i>6</i>
<i>Connections</i>	<i>6</i>
<i>Back Panel</i>	<i>7</i>

Setting up & Tuning In

<i>Master/Slave mode</i>	<i>8</i>
<i>Single Subwoofer Connection</i>	<i>8</i>
<i>Multiple Subwoofer Connection</i>	<i>8</i>
<i>Remote Control and Battery Connection</i>	<i>9</i>
<i>Adjusting settings</i>	<i>10</i>
<i>Switching the Subwoofer On/Off</i>	<i>10</i>
<i>Automatic Mode for On/Standby</i>	<i>10</i>
<i>Temporary Manual mode for On/Standby</i>	<i>11</i>
<i>Subwoofer Level Control</i>	<i>11</i>
<i>Setting Cross-over Frequency</i>	<i>12</i>
<i>Select EXT On or Off</i>	<i>12</i>
<i>Setting Phase</i>	<i>12</i>
<i>Storing and recalling presets</i>	<i>12</i>

Positioning the Subwoofer

<i>Introduction</i>	<i>13</i>
<i>Finding Optimal Settings</i>	<i>15</i>
<i>Level</i>	<i>15</i>
<i>Cross-over frequency</i>	<i>15</i>
<i>Phase</i>	<i>17</i>
<i>Finding Optimal Phase Settings</i>	<i>17</i>
<i>Troubleshooting</i>	<i>18</i>
<i>Factory Defaults</i>	<i>19</i>
<i>Technical Specifications</i>	<i>20</i>

INTRODUCTION

Congratulations!

Thank you for purchasing this Dynaudio subwoofer. With it, you have chosen for the latest in audio technology and engineering, culminating into the finest in audio reproduction.

With their dynamic, accurate performance and ease of integration into even elaborate systems, Dynaudio subwoofers are ideally suited to obtain maximum enjoyment from High-Resolution formats such as DVD-Audio™ and SACD™. These characteristics in combination with sustained high volume level capabilities make Dynaudio subwoofers also an ideal choice for demanding Home Theater set-ups.

In order to obtain the best possible performance from your Dynaudio subwoofer, please carefully read and follow the instructions. We wish you many musical and exciting moments with your Dynaudio Subwoofer.

Wilfried Ehrenholz

Dynaudio.

Features:

- **Powerful integrated amplifier**
- **Full remote control**
- **4 presets to store your favorite settings for volume, roll-off frequency, phase and low frequency extension.**
- **"Master" & "Slave" function for easy integration when using multiple subwoofers**
- **Automatic On/Standby switching through music-sensing**
- **XLR in- and Outputs for interference-free connections**
- **Front and back panel remote control command receivers ("eyes") allow for flexible positioning**

QUICK SETUP GUIDE

This quick set-up guide assumes some knowledge with regards to installing, connecting and using a subwoofer. We strongly recommend that you do read through the instruction manual in order to get the best performance from your Dynaudio subwoofer, even if you already have installed the subwoofer.

Installing:

- Carefully unpack the subwoofer and accessories.
- Install the battery cell in the remote control.
- Connect the processor's or receiver's subwoofer Output to either the RCA or XLR Input.
- Set the Input button to "Master" unless the subwoofer is used in a multiple subwoofer setup where another subwoofer is set as master.
- Set the Preset/Settings switch to "Store".
- Double-check all connections; now connect the supplied mains lead to the subwoofer and AC outlet.

Using:

- Controlling the subwoofer is entirely done by using the remote control. Whenever the subwoofer receives a command from the remote control, the Power status LED will blink.
- Set the mains switch on the back panel of the subwoofer to On. The Power status LED will light up green.
- The subwoofer switches to On or Standby automatically: It will switch to On when a signal presents itself, it will switch to Standby when no signal has been available for 20 minutes. When switched to Standby, the power status LED is red; switched to On, the LED is green.

It is possible to temporarily override Automatic switching: Briefly pressing the green "I" (Power On) button on the remote will switch the subwoofer to On, even if no signal is present. Note that if no music signal presents itself within 20 minutes, the subwoofer will switch back to Standby again. If you prefer the subwoofer to stay switched On all the time -regardless of Input signal- press and hold the green "I" button for 2 seconds to set to Manual Standby/On switching: The Manual status LED will light up green.

Briefly pressing the red "O" (Power Standby) button will switch it to Standby, even if a music signal is still present. Note that on the next occasion a music signal presents itself (after a 20 minute silence), the subwoofer will switch to On again automatically. If you prefer the subwoofer remains switched to Standby all the time -regardless of Input signal- press and hold the red "O" button for 2 seconds to set to manual Standby/On switching: The Manual status LED will light up green.

Pressing either the "I" or "O" button briefly, regardless if the subwoofer is switched On or in Standby mode, will set the subwoofer back to Automatic switching again: The Manual status LED will extinguish.

- Set the subwoofers volume level by pressing the Level "+" or "-" button.
- Select the desired cross-over frequency by pressing either 60, 80, 100Hz or Flat. If cross-over frequency selection is handled by the multi-channel processor or receiver (most cases), select "Flat".
- Select the desired Phase setting by pressing either the 0°, 90°, 180 or 270° button.
- In the Ext Off mode, the very deepest bass will be filtered; this will allow the subwoofer to achieve even higher sound pressure levels. Generally speaking, this setting is best suited for movies and most music. Press the EXT On for deepest bass response, as suited for some music or movie soundtracks with extreme deep bass.
- You can store your settings in one of the 4 presets A, B, C or D. Make sure the Preset/Settings switch on the subwoofers back panel is set to "Store". Press and hold the desired Preset button for 3 seconds to store. The Power status LED will blink 3 times to confirm. Previously stored settings will have been over-written. Set the Preset/Settings switch to "lock" to prevent accidental over-writing of the presets.

To recall a preset, simply press the desired preset button briefly.



Install and make all connections to the subwoofer and rest of the system before switching the system and subwoofer on.

INSTALLATION & CONNECTIONS

Unpacking

Due to its weight and size, we strongly recommend that help is at hand when unpacking and installing the subwoofer. Unpack the subwoofer on a clean, even and soft area; floor carpeting is very suitable. Please refer to Fig. 1.

- The packaging should be opened from the top. Remove all accessories that come packed with the subwoofer, such as AC power cord, remote control and warranty card). Do not remove the top part of the protective material.
- With the protective material still in place but with accessories removed, carefully tilt the packaging on its side and tilt again to turn it upside-down. Ensure that no part of the top-cover is obstructing the opening at the top.
- The outer packaging can now be lifted away from the subwoofer itself. Remove the protective material that now is on top. Through the polythene bag you can now see the underside of the subwoofer.
- Open the polythene bag and remove from around the base of the subwoofer.
- Again, carefully tilt the subwoofer on its side and again to turn it onto its feet. Note that the top part of the protective material will now come off easily so ensure that the subwoofer doesn't drop or slide away in the process.

Check that the contents are complete:

- Subwoofer. The factory-set power requirements (refer to label on rear of subwoofer) should correspond for the region where the subwoofer was purchased. Refer also to chapter "Safety Instructions".
- DSC1 Remote Control.
- AC mains lead. The supplied lead should be suitable for the region where the subwoofer was purchased.
- Instruction Manual.

To decide on the most suitable location for the subwoofer, please refer to chapter "Positioning Subwoofers". Once the subwoofer is positioned in the listening room, it can be connected to the rest of the system.

Making connections

Before making any connections to the subwoofer we strongly recommend that the subwoofer is disconnected from the mains outlet. Refer to figure 2.

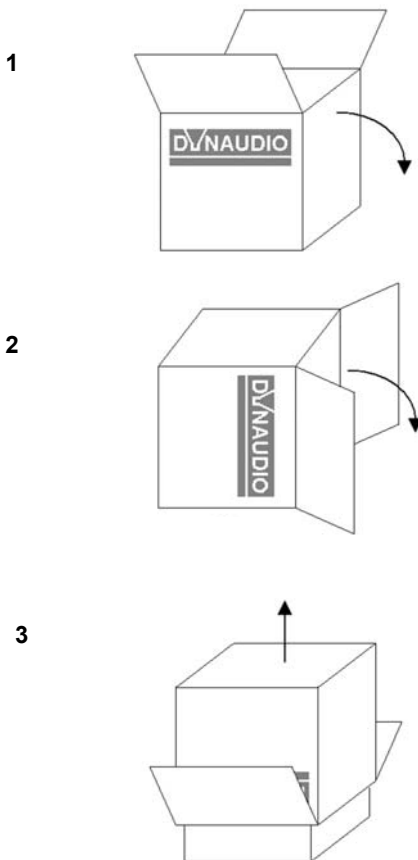

BACK PANEL

Figure 2

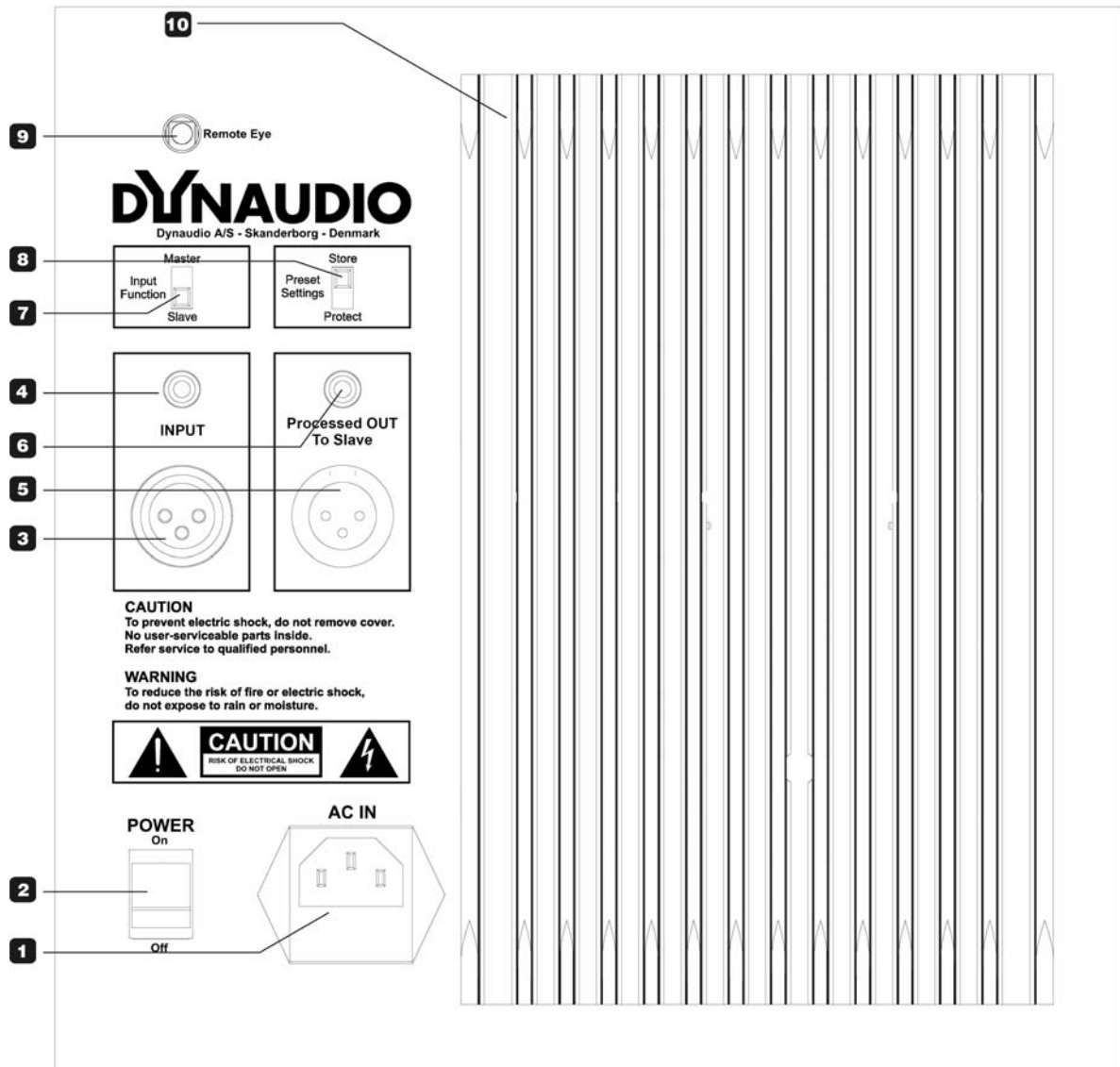

- | | |
|------------------------------------|---|
| 1. Mains power Input. | 6. Unbalanced processed audio Output |
| 2. Power switch | 7. Input Master/Slave function switch |
| 3. Balanced audio Input | 8. Preset/Settings Store & Protect switch |
| 4. Unbalanced audio Input | 9. Remote Control sensor |
| 5. Balanced processed audio Output | 10. Heat sinks |

SETTING UP & TUNING IN

Master and Slave mode

The subwoofer can operate in two different modes: Master or Slave mode. If your system consists of multiple subwoofers, it is desirable that all subwoofers operate with identical settings (Volume, Low-Pass filter (Hz), Phase and LF Extension).

Using the Master/Slave feature of Dynaudio subwoofers this is easily achieved: The Master subwoofer (connected directly to the subwoofer Output of the amplifier or receiver) will control all Slave subwoofers (connected to the Master subwoofer). Thus, using a single remote control, all subwoofers in the system will follow all settings from the Master subwoofer. Note that in Slave mode, only the On/Off and Auto/Manual selections are available.

Single subwoofer connection

- From the processor or receiver's low-level (not a speaker Output) subwoofer Output (often marked as "subwoofer out", "Sub out" or "LFE"), connect a mono RCA-to-RCA (No. 4 in fig. 2; refer also to fig. 3) or XLR-to-XLR patch cord to the subwoofers Input. Refer also to the section "Using the XLR connectors" below in this chapter.
- Set the subwoofers Input switch (No. 7 in fig. 2) to the "Master" position if you wish to use and change the settings with the remote control.
- After all connections are made, connect the supplied mains lead to the subwoofers IEC power socket (No. 1 in fig. 2) and a mains outlet.

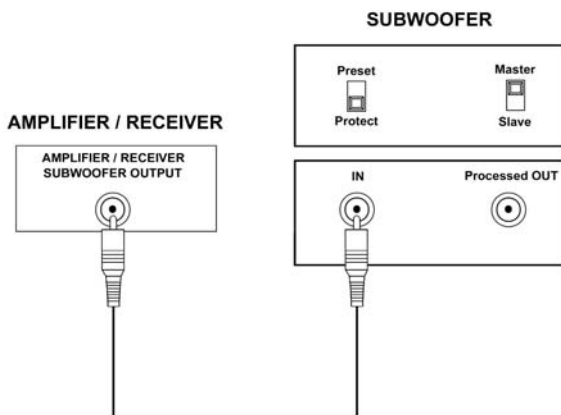

Multiple Subwoofer connection

- From the processor or receiver's subwoofer Output (often marked as "subwoofer out", "Sub out" or "LFE"), connect a mono RCA-to-RCA or XLR-to-XLR patch cord to the Input (No. 4 in fig. 2) of the first subwoofer in the daisy-chain. This is now the Master subwoofer.
- Set the master subwoofers Input switch (No. 7 in fig. 2) to the "Master" position.
- From the Master subwoofers "processed Out" Output (No. 6 in fig. 2), connect a mono RCA-to-RCA or XLR-to-XLR patch cord to the next subwoofers (Slave) Input. Refer also to fig. 4.

- Any subsequent Slave subwoofers can be connected in a daisy-chain style, going from the "processed Out" Output (No. 6 in fig. 2 to the next Slave subwoofers Input.
- Set the Slave subwoofers Input switch (No. 7 in fig. 2) to the "Slave" position.
- After all connections are made, connect the supplied mains leads to the subwoofers IEC power sockets (No. 1 in fig. 2) and a mains outlet.

Figure 4

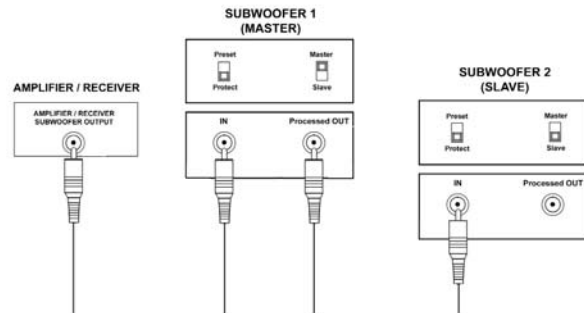

- In order to avoid interference and noise, we recommend you use quality, well shielded cables.
- When using multiple subwoofers in a Master-Slave setup, it is recommended that the subwoofers are all the same model.
- If you wish to use multiple subwoofers with full individual control, set the Input switch for all to the "Master" position. From the Amplifier, processor or receiver's subwoofer Output, use a Y-connector.

SETTING UP & TUNING IN

Connecting using the XLR sockets

A balanced signal connection (XLR sockets) provides a connection that is far less susceptible to cable signal interference compared to an unbalanced connection (RCA connection). It is for this reason that XLR and balanced connections are used almost exclusively in critical and professional installations.

Provided your processor or receiver has a XLR symmetric or balanced Output for subwoofer you should consider using the XLR Input (No. 3 in fig. 2) on the Dynaudio subwoofer. In a setup with multiple subwoofers you can use the XLR connections between the Master and Slave subwoofers, even if the connection between the processor or receiver has been made using the RCA connectors.

Configuring and making connections using XLR is done in the same way as using the RCA connectors. Please refer to the sections "single subwoofer connection" and "multiple subwoofer connections" in this chapter.

Dynaudio follows the most usual convention for termination of XLR sockets:

Pin 1 = ground
Pin 2 = signal +
Pin 3 = signal -



- Always ensure that all connections are correct: It may be that the source equipment follows a different way of terminating the XLR sockets or it may be that the XLR connection cables themselves do not comply. When in doubt, consult your dealer.
- DO NOT use XLR and RCA connections in parallel at the same time for the same connection.

Fig. 5

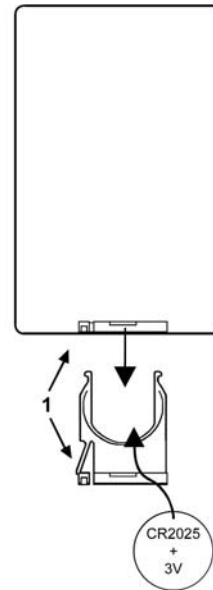

Remote Control battery & battery replacement

Before the DSC 1 remote control can be used, it needs to be fitted with the battery cell that comes separately packed with the remote control. To replace and insert a battery (refer to fig. 5):

- Release the battery tray by pushing its locking tab (No. 1 in fig. 5) on the back of the remote sideways with your nail and at the same time; slide the tray out of the remote control battery compartment.
- Remove the exhausted battery and dispose of properly. Insert a fresh battery in the battery tray: Observe correct polarity (both battery and tray are marked with a "+").
- Slide the battery tray into the battery compartment until the locking tab clicks into place. Make sure it is inserted the correct way up, the tray will slide into place easily, do not use force.



- The battery will last a considerable time, depending on frequency of use. When you notice that the subwoofer doesn't always respond or only from a very close range to commands from the remote control, it is likely the battery is exhausted and will need replacing.
- Use only CR2025 button cell batteries to replace the original battery with; these are readily available from most electrical stores.

Do not leave the remote control in high temperature environments (such as in direct sunlight). In worst cases this can possibly result in deformation of the remote control.

SETTING UP & TUNING IN

Adjusting the settings and using the subwoofer

Once you have ensured yourself that all necessary connections have been made, the subwoofer can be switched on and used. With the exception of the mains power switch (No. 2 in fig. 2) controlling the subwoofer is done through the DSC 1 remote control; the numbering at the beginning of each section corresponds to the numbering in fig. 6.

Fig. 6

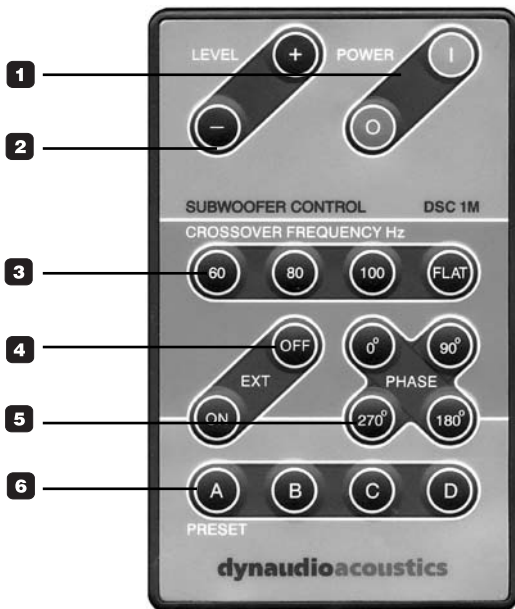

1. Subwoofer manual On/Off
2. Subwoofer Volume level
3. Subwoofer Roll-off frequency setting
4. LF Extension On/Off
5. Subwoofer Phase selection
6. Configuration presets

Switching the subwoofer On and Off

The Power Switch on the subwoofers back panel switches the subwoofer completely off: Set to the Off position, the subwoofer will not respond to commands from the remote control. For normal operation, the switch will always be set to the On position.

- Switch the subwoofer on with the Power switch on the back panel.
- The Status LED (No. 2 in fig. 7) on the front of the subwoofer will light up green.

Automatic Mode for On/Standby

The subwoofer switches to On or Standby automatically: Automatic switching works by signal-sensing. As long as a music signal is available on the subwoofers Input, it will remain switched on. After 20 minutes of not sensing any Input music signal or receiving a signal from the remote control, the subwoofer will automatically switch to Standby mode.

When in Standby mode, the Power status LED (No. 2 in fig. 7) is red; when switched to On, the LED is green. During the minute prior to switching to Standby, the Status LED (No. 2 in fig. 7) will alternate slowly between green and red to indicate it is about to switch to Standby.

Even in automatic mode, it is possible to switch the subwoofer to Standby or On, using the on/standby buttons (buttons in No. 2 in fig. 6):

- By pressing the upper button briefly, the subwoofer will switch On (if it was already on, nothing will happen). Note that if no music signal presents itself within 20 minutes, the subwoofer will switch back to Standby again.
- By pressing the lower button briefly, the subwoofer will switch to Standby (if it was already in Standby, nothing will happen). Note that on the next occasion a music signal presents itself (after a 20 minute silence), the subwoofer will switch to On again automatically.

The Power status LED (No. 2 in fig. 7) will show if the subwoofer is in Standby mode (LED is Red) or On (LED is green).

SETTING UP & TUNING IN

Fig. 7

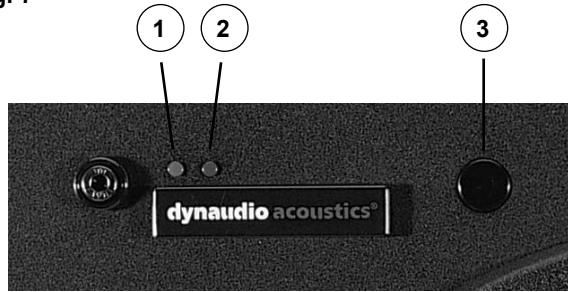

1 Manual Mode (Manual/Automatic) LED.
Green = Manual mode
Off = Automatic mode

2 Power Status LED
Green = On
Red = Standby
Off = completely Off

3 Remote control command receiver.

Temporary Manual Mode for On/Standby

It is possible to temporarily override Automatic switching: Briefly pressing the green "I" (Power On) button on the remote will switch the subwoofer to On, even if no signal is present. Note that if no music signal presents itself within 20 minutes, the subwoofer will switch back to Standby again.

Briefly pressing the red "O" (Power Standby) button will switch the subwoofer to Standby, even if a music signal is still present. Note that on the next occasion a music signal presents itself (after a 20 minute silence), the subwoofer will switch to On again automatically.

If you prefer the subwoofer to stay switched On or to Standby all the time -regardless of Input signal- you can override the Automatic mode completely in two different ways. The Manual status LED (top button in No. 2 in fig. 6) indicates to which state the subwoofer is set: Manual LED is lit green; in Automatic mode, LED is off.

- Press and hold the green "I" button (top button in No. 2 in fig. 6) for 2 seconds to set to Manual Standby/On switching: The Manual status LED (No. 1 in fig. 7) will light up green. If the subwoofer was already switched On, it will remain On; if it was set to Standby, it will switch to On.
- Press and hold the red "O" button (lower button in No. 2 in fig. 6) for 2 seconds to set to Manual Standby/On switching: The Manual status LED (top button in No. 2 in fig. 6) will light up green. If the subwoofer was already switched to Standby, it will remain in Standby; if it was switched On, it will switch to Standby.

The subwoofer can be switched from Standby either manually or automatically. The subwoofer is factory-set at Automatic, as this will be the most convenient setting in most cases.

Back to Automatic mode:

Press either the "I" or "O" button briefly. Regardless if the subwoofer is switched On or in Standby mode, the subwoofer will switch back to Automatic mode again: The Manual status LED will extinguish.



- Unlike all other functions on the remote control, the On/Standby buttons remain active when the subwoofer is set to "Slave" mode.
- When powering up, the subwoofer always reverts to the same settings as when it was switched off. Even if mains power is removed completely for a prolonged period of time, the last settings will be retained.

Subwoofer Level control

- Press Level + (upper button No. 1 fig. 6) to increase the volume of the subwoofer, release when the desired level has been reached. Each short, momentary press will increase the volume level with 1 dB.
- Press Level - (lower button No. 1 in fig. 6) to decrease the volume of the subwoofer, release when the desired level has been reached. Each short, momentary press will decrease the volume level with 1 dB.

The right volume level is one of the critical aspects of correct and seamless integration of any subwoofer as part of a speaker system. Please refer to the chapter "Finding the correct settings" for more information.



- Together with the other settings, the volume level can be stored in one of the 4 presets. Refer to section "Storing and recalling Presets" in this chapter. Together with the other settings Cross-over frequency and Phase we recommend that, once found, you store the optimum volume level into one of the presets.
- The Volume control is disabled when the subwoofer is set to "Slave" mode. Refer also to section "Master and Slave Mode" in this chapter.

SETTING UP & TUNING IN

Setting the Cross-over Frequency

The Cross-over frequency can be set to four positions: 60, 80, 100Hz and Flat. The roll-off slope is 24dB per octave. In most cases, selecting cross-over frequencies is done through the bass-management system of your processor or receiver. In this case, use the "Flat" position. Refer to the instruction manual of the processor or receiver how to set cross-over frequency.

- Press the button for the desired position. When pressing the button, ensure that the command from the remote control is received (the Power Status LED; No. 2 in fig. 7 blinks).

Check the owner's manual of the other speakers in the system if a specific frequency is recommended. Please refer to the chapter "Finding the optimal settings" for more information.



- Together with the other settings, the Cross-over frequency can be stored in one of the 4 presets. Refer to section "Storing and recalling Presets" in this chapter. Together with the other settings Volume and Phase we recommend that, once found, you store the correct cross-over frequency into one of the presets.
- The Cross-over frequency control is disabled when the subwoofer is set to "Slave" mode. Refer also to section "Master and Slave Mode" in this chapter.

Selecting EXT On or Off

EXT stands for Extension, in this case Low Frequency Extension. Dynaudio subwoofers allow for deep and accurate bass response even at high levels. In the EXT Off mode, the very deepest bass will be mildly filtered; this will allow the subwoofer to achieve even higher sound pressure levels. Generally speaking, this setting is best suited for movies and most music. Some movies and high quality, audiophile recordings can contain extreme low frequencies. To experience these:

- Press the EXT On button (lower button in No. 4, fig. 6) to switch Low Frequency extension on.
- Together with the other settings, the Low Frequency Extension status can be stored in one of the 4 presets. This way, you can program the EXT switched On as part of a setting for "audiophile listening" and program EXT Off as part of a setting for "cinema mode" for instance. Refer to section "Storing and recalling Presets" in this chapter.
- If you use a turntable, you will get the best results with EXT switched off. Many vinyl records contain, and the turntable itself will generate, very low frequencies (rumble) which, with the subwoofers low frequencies capabilities can otherwise prove distracting from enjoying the music.

- The EXT mode is disabled when the subwoofer is set to "Slave" mode. Refer also to section "Master and Slave Mode" in this chapter.



- Loud volume levels over prolonged periods of time can cause permanent damage to your hearing!

Setting Phase

The Phase setting of the subwoofer has been factory-set at 0° which in many cases will be the appropriate setting. Press the 0°, 90°, 180° or 270° button (No. 5, fig. 6) to select the desired phase setting.



- Together with the other settings, the Phase setting can be stored in one of the 4 presets. Refer to section "Storing and recalling Presets" in this chapter. Together with the other settings, Volume and Cross-over frequency, we recommend that, once found, you store the correct phase setting into one of the presets.
- The Phase selector is disabled when the subwoofer is set to "Slave" mode. Refer also to section "Master and Slave Mode" in this chapter.

Storing and recalling presets

With four presets available you have the flexibility of recalling different sets of subwoofer settings, depending on what suits the occasion best. For instance, you may store the settings best suited for classical music setting under Preset A, program Preset B to have the best settings for action movies and program Preset C for late-night listening, etc.

The presets are also an excellent tool for recalling different settings when experimenting with either location or settings of the subwoofer.

Once you have stored all presets, you can choose to block access to storing, so that presets can not be over-written by mistake.

Each preset stores settings for Volume Level, Cross-over frequency, LF Extension and Phase.

To store a preset:

- Ensure that Preset programming hasn't been blocked: The Preset/Settings switch on the subwoofers back panel (No. 8 in fig. 2) must be in the "Store" position.
- Set all parameters (Volume Level, Cross-over frequency, LF Extension and Phase) to your liking.
- Press and hold the desired Preset A, B, C or D button (No. 6 in fig. 6) for 3 seconds. Ensure that the subwoofer receives the commands from the remote control without interruption.
- The Status LED (No. 2 in fig. 7) will blink 3 times to confirm the preset has been stored. Any previously

POSITIONING THE SUBWOOFER

stored settings has been overwritten with your new settings.

- To avoid accidental over-writing of presets, set the Preset/Settings switch on the subwoofers back panel (No. 8 in fig. 2) to the "Protect" position. Adjustments on-the-fly for all settings are still possible.

To recall a Preset:

- Simply briefly press the desired Preset button A, B, C or D.



- Presets can only be stored or recalled in "Master" mode.
- Program one preset with the best global settings for your system and use this as the starting point to program the other presets. This way you always have a starting and reference point.

Introduction

Although it is often said that the location of a subwoofer in a listening room is not critical (as the human ear can not locate direction at very low frequencies) we recommend that you choose its position carefully so the subwoofer can integrate fluently with the other speakers in the system and interact in the correct way with the acoustical environment.

All of the following should be taken as rule-of-thumb guidelines; bass response in general is very dependent on the acoustics of the listening environment. Finding the best position often involves a lot of trial-and-error experimenting. Always trust your ears, even if seemingly the position of the subwoofer goes against the guidelines. Contradictory as it may seem, good integration of subwoofers has been achieved when one isn't aware that a subwoofer is present at all in the system, yet performance involves fast, deep and solid bass without sounding stressed, even at loud levels.

- Trying to find the right location will also involve finding the right settings such as Level, Cross-over frequency and Phase for that location. The subwoofers presets will prove to be a useful tool when trying to find a suitable setting: You can store the settings that match a particular position so you can easily swap between locations. It will also allow you to make small changes in settings and to store these as separate presets. This way, you can compare between presets to find the best setting. Refer also to section "Storing and recalling a Preset" in Chapter "Adjusting and Using the subwoofer".
- When experimenting to find the optimal location, use a couple of music tracks with repetitive bass across a large spectrum. The tracks should be sufficiently different from each other and each should cover a wide bass-range. Musical instruments, such as a double-bass, bass guitar, church organ, etc. cover a wide spectrum in the bass region and are therefore very suitable. Using non-music (such as action movies) material to position and adjust the subwoofer with, may lead to spectacular results with such material but almost always it will result in overblown and excessive bass when playing music with the same setting. Remember that the Dynaudio subwoofers allow for 4 different preset settings, so you can store a preset with the setting that matches the occasion (be it for action movie or music listening) best.

Every listening environment will have specific "room-modes", whereby in some specific locations in the room and at particular frequencies, the bass may be too much or too lean. This effect will be stronger in square and "shoe-box" shaped rooms. With a single subwoofer, the better position for the subwoofer relative to the listening position will be the one where bass is perceived to be neither too much or too lean at any given frequency.

POSITIONING THE SUBWOOFER

Fig. 8

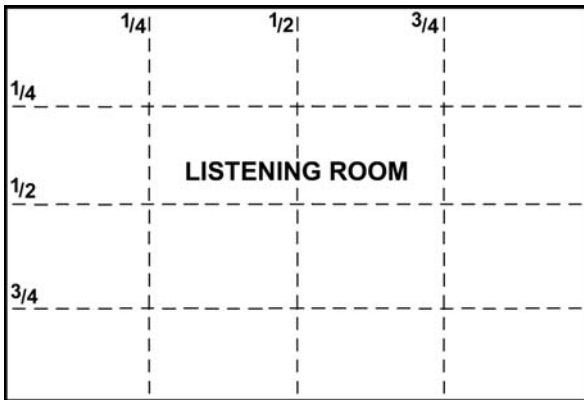

- Generally, avoid placing the subwoofer at $\frac{1}{4}$, $\frac{1}{2}$ or $\frac{3}{4}$ of either the length or width of the room as at these locations the room-modes are likely to be strongest (the dashed lines in fig. 8)

Fig. 9

Corner placement

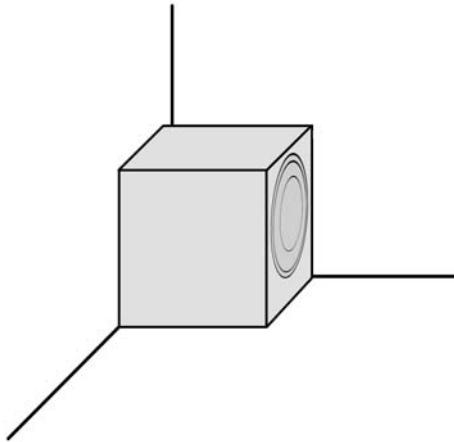

Maximum boost of bass level but potentially uneven distribution of bass in the room (room-modes), particularly if the room is square or shoe-box shaped.

From the listening position, check if the bass is even across the entire bass spectrum. If not, move the subwoofer out of the corner. Try moving it along either wall.

Fig. 10

Next to the wall - away from the corner

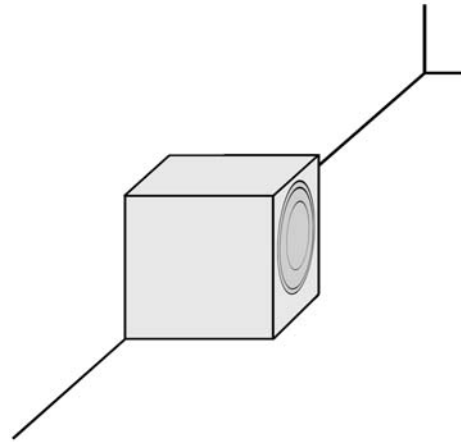

This position still provides considerable boost but less than the corner placement as above. Room-modes can also still be considerable but less so than with corner placement.

From the listening position, check if the bass is even across the entire bass spectrum. If not, move the subwoofer away or towards your listening position until most even response has been obtained.

Avoid placing the subwoofer exactly half-way or at a quarter of the wall's length (refer to fig. 8).

Free standing, away from wall and corner

Fig. 11

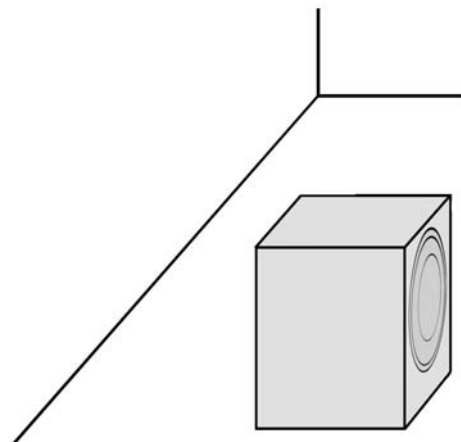

This position will give least boost compared to wall or corner placement, but in general offers best flexibility at achieving most even bass distribution at the listening position.

Avoid placing the subwoofer exactly half-way or at a quarter's length of either sidewall (refer to fig. 8). Particularly in smaller square or "shoe-box" shaped rooms the free standing position is recommended.

FINDING THE OPTIMAL SETTINGS

Multiple subwoofers.

By using carefully positioned multiple subwoofers it is possible to even out the different room-modes and thus create a more coherent overall bass response in the room. It is worth experimenting with different locations around the room for the additional subwoofers, even using the rear of the room. As adding subwoofers will not increase the effect of room-modes, even adding a subwoofer without much care or thought to positioning is likely to help even out room-modes.



Always position subwoofers at least 1 mtr/3 ft away from a television as the magnetic field emanating from the subwoofer may otherwise distort the picture. If you see discolorations on the television screen, try moving the subwoofer and other speakers close by away from the television.

Finding the correct settings

Before deciding on a final setting, you will probably want to experiment with both location and adjustment of the subwoofer. Here, the subwoofers presets will prove an ideal tool. When trying to decide on a particular location, simply store the settings that are best for the location and swap back and forth, using the appropriate preset every time. Refer also to section "Storing and recalling a Preset" in Chapter "Adjusting and using the subwoofer".

- When experimenting to find the optimal settings, use a couple of music tracks with repetitive bass across a large spectrum. The tracks should be sufficiently different from each other and each should cover a wide bass-range. Musical instruments, such as a double-bass, bass guitar, church organ, etc. covering a wide spectrum in the bass region and above, are very suitable as these depend on accurately balanced subwoofers and main speakers.
- Although in general it is best to make adjustments in the sequence outlined below, note that changing one setting may influence another. For example, finding the right setting for "Phase" may result in having to decrease "level", even if this was set correct before. It is recommended that you double-check the previous settings before moving on to the next one. Obtaining the best integration of the subwoofers generally involves a considerable amount of repeated fine-tuning.
- Once done, use the presets to store the settings. It is advisable to reserve one preset as the "system default" settings so you can always revert to this setting when you have made temporary changes to any of the settings.

Level

With the "+" and "-" Level buttons (No. 2 in fig. 6) you can adjust the relative volume level of the subwoofer to the main speakers of the system:

- Play the same track a couple of times, adjusting the level so that the instrument sounds homogenous across its range.
- If you find that at certain specific bass tones the response is either too loud (bloated sound) or soft (thin sound), it may be that you have to experiment further with the location of the subwoofer and/or the cross-over settings. Refer to the chapter "positioning the subwoofer" and section "Cross-over setting" in this chapter.



When using multiple subwoofers, ensure that all settings such as level, cross-over frequency, phase and LF extension are identical. Use the "Master" and "Slave" mode options to ensure that all subwoofers operate on the same settings (refer to chapter "Installation and Connections", section "Master and Slave mode").

Cross-over frequency

With the Cross-over frequency setting you can select up to what frequency the subwoofer will work. Fig. 12 shows the effect of each setting. Note that curves are for explanation purposes only.

Fig. 12

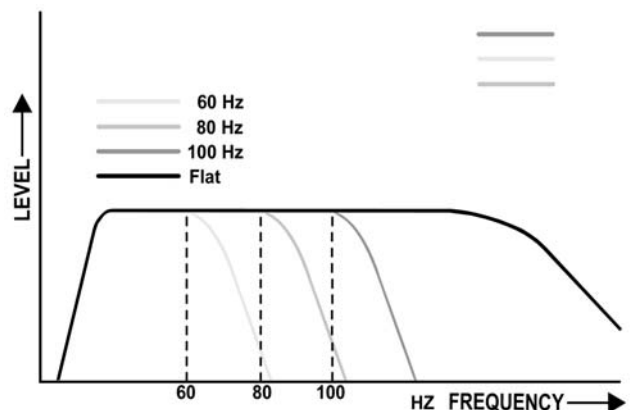

Selecting the ideal cross-over frequency depends in most part on the main speakers. Ideally, the signal to these speakers has passed a low-frequency filter so that these can take over seamlessly from the subwoofer at the correct cross-over frequency. If the cross-over frequency for the main speakers has been set too high (or looking at it differently, the cross-over point for the subwoofer is set too low), there will be a significant gap in the combined

FINDING OPTIMAL SETTINGS

frequency response; see fig. 13. In the same manner, with the cross-over frequency for the main speakers set too low (cross-over freq. for the subwoofer too high), there will be too much of an overlap between subwoofer and main speakers, again resulting in incorrect overall frequency response; see fig. 14. Correct settings are illustrated in fig. 15.

Fig. 13
Subwoofer cross-over frequency set too high (main speakers too low): Bump in frequency response.

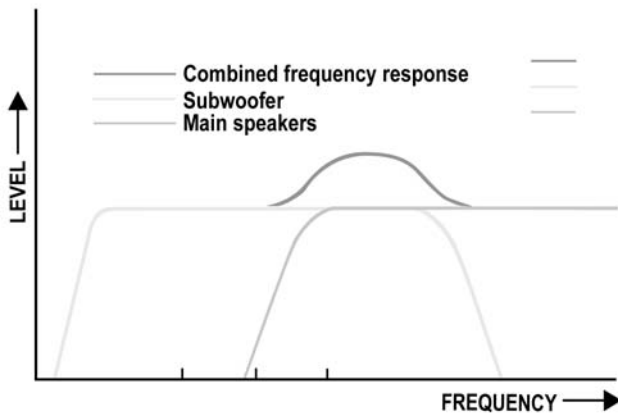

Fig. 14
Subwoofer cross-over frequency too low (main speakers too high): Gap in frequency response

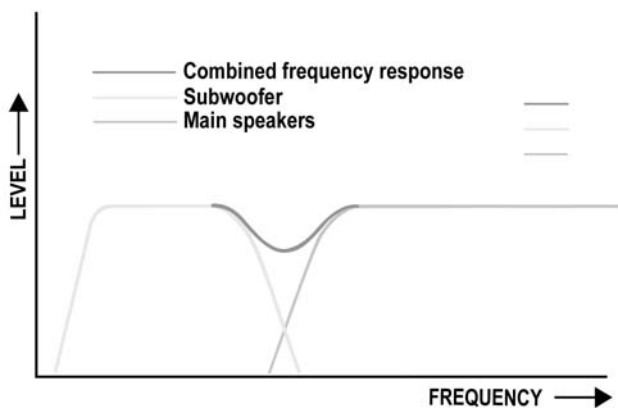
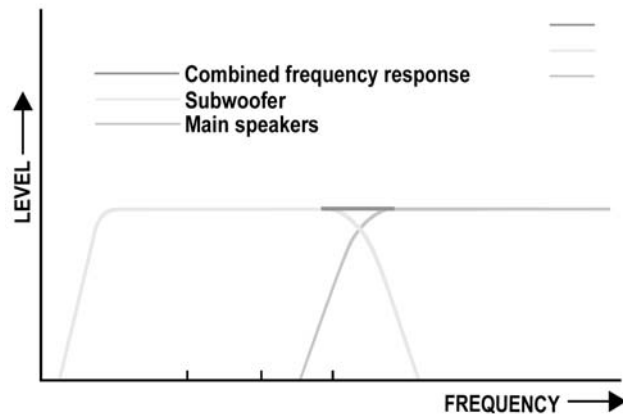

Fig. 15
Subwoofer & main speakers cross-over frequencies set correctly: Smooth frequency response.



Many multi-channel processors and receivers provide elaborate bass-management systems where the cross-over frequency for both subwoofer and main speakers can be set. If you are using such a bass-management system, you can select the "Flat" setting on the subwoofers remote control, as all filtering has been done by the bass-management system. Carefully follow the instructions for the amplifier/processor or receiver.



- If you are using your system's bass-management system, ensure that the subwoofers cross-over frequency hasn't been set to the same or lower frequency compared to the setting chosen with the bass management system.
- Selecting the correct frequency depends to a large extent on the main speakers. Sometimes main speakers are specifically intended to work with a subwoofer. In such cases, the main speakers can get damaged by a full-range amplifier signal. If in doubt, check the instruction manual for the main speakers for any restrictions or recommendations.

Of course it is possible to combine the subwoofer in a system where the loudspeakers are being fed with a full-range signal. In that case, setting the cross-over frequency for the subwoofer depends very much on the natural roll-off frequency in the bass of the main speakers. In general, a large, floor-standing speaker will still have significant Output in the deeper bass range, in which case the cross-over frequency should be set to 60Hz. A small or very small speaker will have less deep bass Output in which case the setting should be 80Hz. or 100Hz. To find the correct setting in such scenarios:

- Play a music track that has a significant amount of bass over a large bass region. An instrument such as a double-bass or bass-guitar is very suitable. Starting with the "60" Hz position (first button left in row No. 3 in fig. 6), use this track to set the subwoofers relative volume level.

FINDING OPTIMAL SETTINGS

- Listen carefully to the bass-line played by the instrument. As it goes up and down in the bass range, the overall bass volume should remain the same, be it with very deep or higher bass notes. Particularly with very small main speakers, it may be that you can hear a "hole" in the bass response: You can hear the deepest bass notes and everything from lower midrange easily, but overall the bass leaves a thin impression. On the other hand, it may be that using the 60Hz setting the system already sounds good. In both cases, select the next setting, "80" Hz.
- Playing the same track at the same volume level, again listen to the overall bass volume level. If the apparent hole in bass response is still present or if the system sounds good now, move on to the next setting, 100Hz. Should the bass volume suddenly become louder or bloated at certain tones compared to the 60Hz setting earlier, revert to this setting; in this case setting the cross-over frequency is done.
- Again play the track to listen to the overall bass volume level. If the bass sounds correct now, leave the setting at 100Hz. Should the bass volume suddenly become louder or bloated at certain tones compared to the 80Hz setting earlier, revert to this setting.

Phase

With the phase settings you can adjust the timing relationship between the subwoofers and main speakers. If either subwoofer or main speaker are slightly delayed in response in relation to the other, it can result in decreased bass Output in the frequency response area where they overlap each other..

The Phase relationship between subwoofer and satellite speakers is very dependent on relative distance, construction and working principles of the main speakers. Fig 16 shows a case whereby phase of the subwoofer and main speakers are incorrect in the critical overlap area, thus significantly reducing acoustic Output in the listening room in that area.

Fig. 16

Incorrect phase relation of subwoofer to main speakers in critical overlap area: Reduced acoustical Output in overlap area, even if levels are set correct.

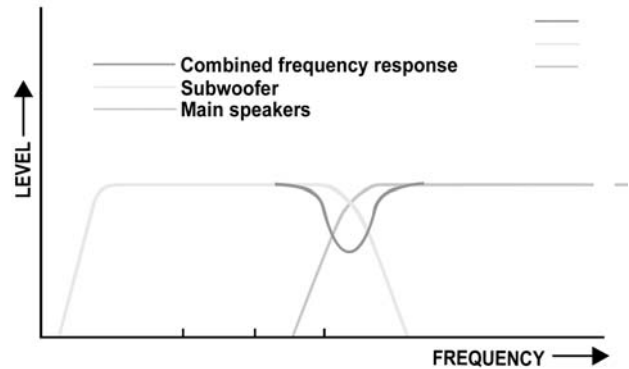

Finding optimal Phase Settings

- Playing the same bass-rich track which also covers the overlap area, repeatedly press the 0° , and its opposite phase, the 180° button in succession. Without changing volume level, do the same with the 90° and its opposite phase, the 270° button (No. 5 in fig. 6). Note which set of phase settings (0° - 180° or 90° - 270°) provides the biggest difference in bass response.
- Using the set of phase settings found in the step above (either 0° - 180° or 90° - 270°) press each of the two buttons in alteration. The position in which you experience the most bass is the correct setting, even if it appears that the bass is too much (this can be adjusted for later).

TROUBLESHOOTING

Problem	Cause	Solution
The subwoofer switches itself off while music is being played	<ul style="list-style-type: none"> There is hardly any low-frequency signal available in the signal. This can happen if the music or movie itself does not contain very low frequencies (e.g. long dialogues) and if the processor or receiver already performs bass-management. 	<ul style="list-style-type: none"> Use the temporary manual On/Standby facility by pressing the green "I" button on the remote for more than two seconds.
The subwoofer responds intermittently to remote control commands	<ul style="list-style-type: none"> The remote control battery is becoming weak. The remote control eye (either front- or back panel) is obstructed. The subwoofer is in direct, strong sunlight 	<ul style="list-style-type: none"> Replace battery Ensure there is a clear line-of-sight from the remote control to either the front- or back panel remote receiver. If this is not possible, consider an IR repeating system which consists of a separate remote receiver which connects by wire to a remote control emitter which can be positioned close to the subwoofers remote eye. Avoid placing the subwoofer in strong direct sunlight.
The subwoofer will not switch on at all	<ul style="list-style-type: none"> AC mains cable has become disconnected (no LEDs are lit). Mains switch on the back (No. 1 fig. 2) is switched to off (no LEDs are lit). 	<ul style="list-style-type: none"> Reconnect mains cable Switch mains back on Check if all signal cables are connected properly. Make sure to switch the system off first before making any changes.
The subwoofer will not switch on automatically	<ul style="list-style-type: none"> No signal is present on either of the subInputs (Status LED is red) The subwoofer has been set to temporary manual On/Standby switching. (Manual status LED is green) 	<ul style="list-style-type: none"> Check if all signal cables are connected Make sure to switch the system off first before making any changes. Check if the subwoofer Output on the source is engaged. Switch back to automatic On/Standby facility by briefly pressing the green "I" button on the remote: The subwoofer will switch on and the Manual status LED will extinguish properly.
The subwoofer will not switch to standby automatically	<ul style="list-style-type: none"> The subwoofer has been set to temporary manual On/Standby switching. (Manual status LED is green) 	<ul style="list-style-type: none"> Use the temporary manual On/Standby facility by pressing the red "O" button on the remote for more than two seconds: The subwoofer will switch to Standby and the Manual status LED will extinguish.
I cannot store a setting	<ul style="list-style-type: none"> Preset/Setting switch (No. 8 fig. 2) is set to "protect" 	<ul style="list-style-type: none"> Set Preset/Setting switch from "Protect" to "Store"
Subwoofer is switched on but no sound from the subwoofer	<ul style="list-style-type: none"> No signal is present on either of the subwoofers Inputs. In the processor or receiver's bass-management set-up, subwoofer has been disabled Subwoofer volume level has been turned down all the way on the amplifier or receiver. Subwoofer volume level has been turned down all the way with the subwoofers remote control 	<ul style="list-style-type: none"> Check if all signal cables are connected properly. Make sure to switch the system off first before making any changes. Check settings in Bass Management menu of the connected amplifier or receiver. Carefully and gradually Increase the subwoofer volume level on the amplifier or receiver. Carefully and gradually Increase the subwoofer volume level with its remote control.

FACTORY DEFAULTS

Factory Default settings.

The factory default settings are as follows:

Power Mode:	Automatic
Phase:	0°
Level:	0dB
EXT:	On
LF Cut-off:	100Hz

To reinstate the factory default settings:

- Switch the subwoofer off completely using the switch on the back panel (No.2 in fig.2).
- Wait for at least 10 seconds.
- Press and hold the "A" preset button (No. 6 in fig 6).
- While holding down the "A" preset button, switch on subwoofer back on: The power Status LED will start to flash green.
- Release the "A" preset button. The subwoofer is now reset to the factory default settings.



All previously stored presets will be deleted also when resetting to factory defaults

TECHNICAL SPECIFICATIONS

Technical Specifications for BM10S BM12S

	BM12S	BM10S
Frequency Response (+/- 3 dB)	18 Hz - 250 Hz	25 Hz - 250 Hz
Low Frequency Limit*	18 Hz - 27 Hz	25 Hz - 33 Hz
High Frequency Limit*	60 Hz - 250 Hz	60 Hz - 250 Hz
Amplifier Power	250 W @ 4 Ohms	200 W @ 5 Ohms
Crossover Frequencies	60 Hz / 80 Hz / 100 Hz	60 Hz / 80 Hz / 100 Hz
Crossover Slope	4th order Linkwitz-Riley	4th order Linkwitz-Riley
Crossover Bypass	Yes (Flat)	Yes (Flat)
Phase adjustment	0° / 90° / 180° / 270°	0° / 90° / 180° / 270°
Inputs	Single ended/RCA, Balanced/XLR	Single ended/RCA, Balanced/XLR
Input Sensitivity for Full Output*	0.1 V - 5 V	0.1 V - 5 V
Maximum Input	10 V	10 V
Input Impedance	20 k Ohms	20 k Ohms
Output	Single ended/RCA, Balanced/XLR	Single ended/RCA, Balanced/XLR
Master / Slave Link	Yes	Yes
Remote Control	included	included
No. of Presets	4	4
Each Preset includes	level, crossover frequency, phase, extended frequency range	level, crossover frequency, phase, extended frequency range
Drive Unit	12" (30 cm), long throw	10" (24 cm), long throw
Magnetic Shielding	Yes	Yes
Internal Cabinet Volume	36 litres	19 litres
Bass Principle	Closed	Ported
Power Consumption Max.	480 W	480 W
Power Consumption Standby	5 W	5 W
Mains Voltage**	120 V/60 Hz or 230 V/50 Hz	120 V/60 Hz or 230 V/50 Hz
Weight (net)	28.2 kg	16.7 kg
Dimensions (W x H x D)	360 x 378 x 576 mm	320 x 338 x 474 mm

* Depended on setting

** Please refer to your local network

Note: Technical specifications are subject to change without notice.